

捕虫器
タイプ L

作図日
2018/03/28

使用蛍光灯
KL2681 1L

《斜视图》

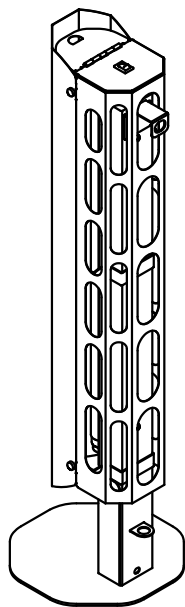
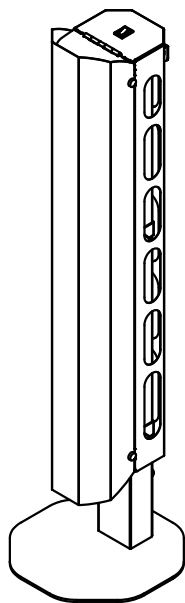

《正面图》

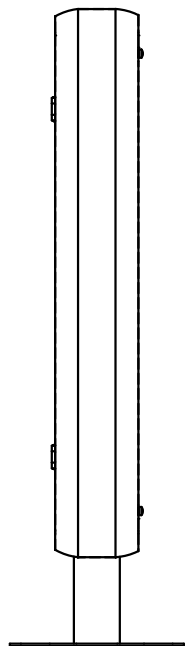

《背面图》

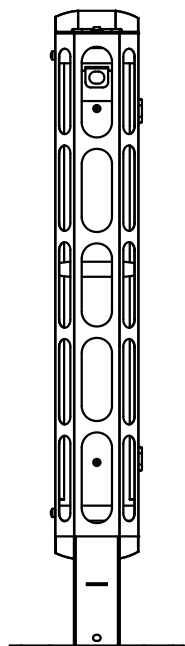

《平面图》

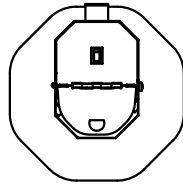

《底面图》

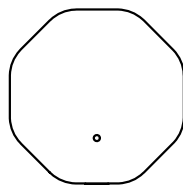

《右側面図》

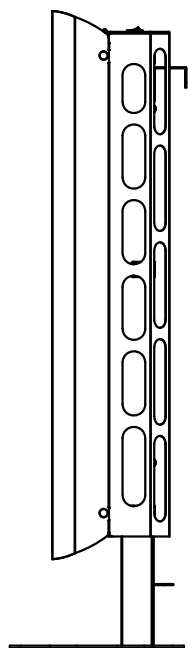

《左側面図》

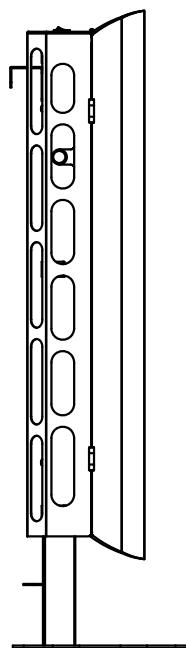

《カバー開放正面図》

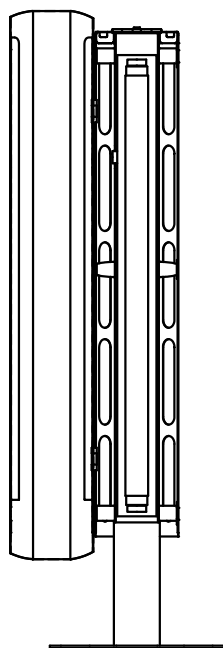

《カバー開放平面図》

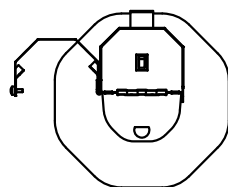

《各部名称参考図 1》

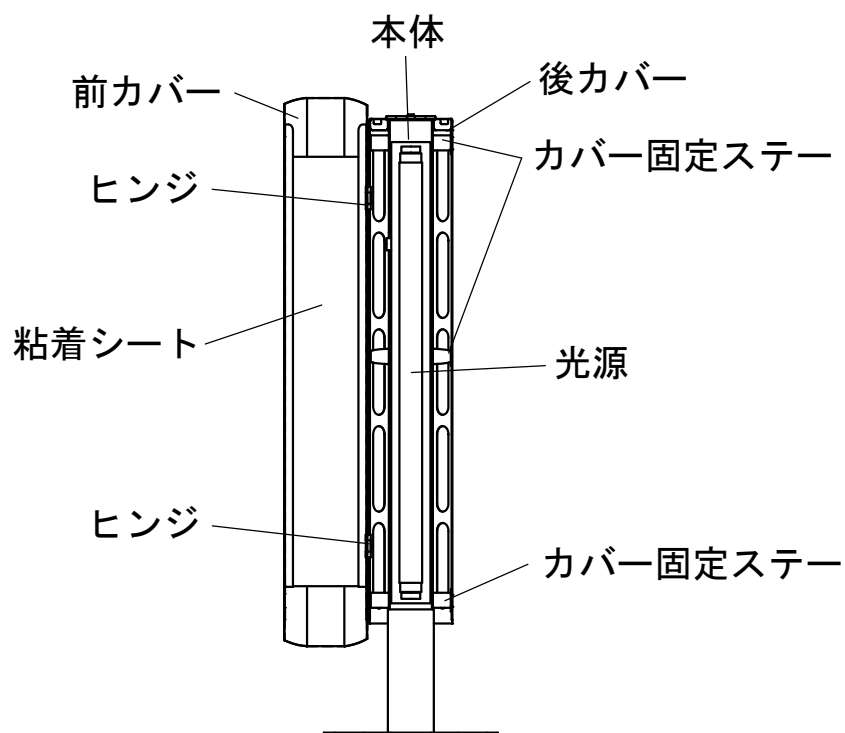

《各部名称参考図 2》

